



W H O L E S A L E  
M I L L W O R K

WOOD MOULDING PROFILES

## Category Index

|                      |       |
|----------------------|-------|
| Door and Window..... | 2-10  |
| Ceiling.....         | 11-14 |
| Wall.....            | 15-17 |
| Panel.....           | 19-22 |
| Door.....            | 26-27 |
| Rail.....            | 28-30 |
| Miscellaneous.....   | 31-33 |

## Profile Index

|                     |       |
|---------------------|-------|
| Astragal.....       | 25    |
| T-Astragal.....     | 25    |
| Back Band.....      | 8     |
| Baluster.....       | 29    |
| Base.....           | 17-19 |
| Base Cap.....       | 20    |
| Bed.....            | 11    |
| Brick.....          | 25    |
| Casing.....         | 1-3   |
| Chair Rail.....     | 14-16 |
| Champher.....       | 31    |
| Corner Guard.....   | 30    |
| Cove.....           | 12    |
| Crown.....          | 10-11 |
| Dentil.....         | 12    |
| Dentil Crown.....   | 10    |
| Drip Cap.....       | 30    |
| Extension Jamb..... | 4     |
| Full Round.....     | 29    |
| Glass Bead.....     | 8     |
| Half Round.....     | 22    |
| Hand Rail.....      | 27    |
| Lattice.....        | 23    |
| Mantel.....         | 32    |
| Mullion.....        | 22    |
| Panel.....          | 23    |
| Parting Bead.....   | 30    |
| Picture.....        | 30    |
| Pilaster.....       | 2     |
| Plinth.....         | 8     |
| Ply Cap.....        | 31    |
| Porch Rails.....    | 27    |
| Quarter Round.....  | 19    |
| Rake.....           | 13    |
| Sash Bead.....      | 24    |
| Screen Bead.....    | 24    |
| Screen Stock.....   | 18    |
| Shoe.....           | 20    |
| Stair Items.....    | 21    |
| Stool.....          | 5-7   |
| Stop.....           | 26    |
| Wainscot.....       | 24    |
| Window Sill.....    | 9     |

## Item Index

Center of booklet after page 16. (4 pages total)

# CASING

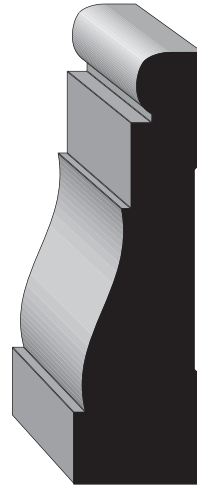

**WM376** 11/16 x 2-1/4

**WM371** 11/16 x 2-1/2

**WM370P** 11/16 x 2-3/4

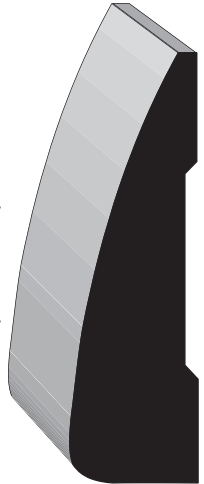

**WM327** 11/16 x 2-1/4

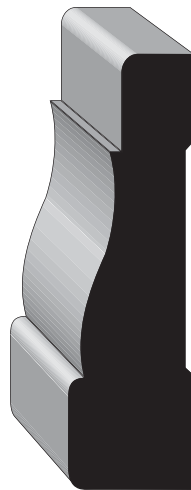

**WM356** 11/16 x 2-1/4

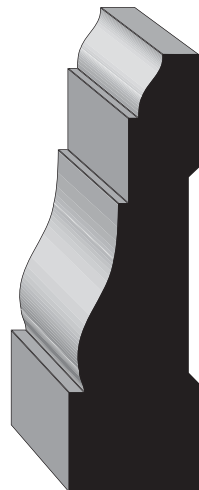

**WM366** 11/16 x 2-1/4

**WM361** 11/16 x 2-1/2

**WM361W** 11/16 x 3-1/2

# CASING

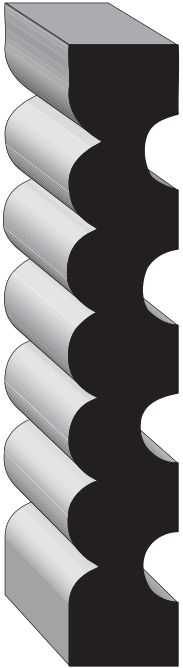

**WM37** 11/16 x 3-1/4



**WM472** 9/16 x 2-1/2  
**WM432** 9/16 x 3-1/2

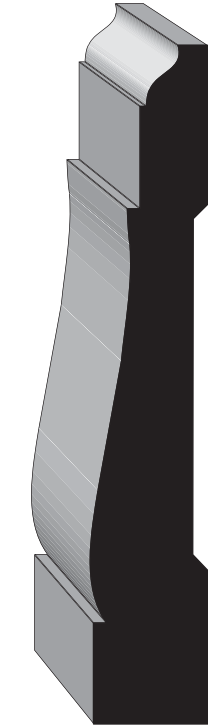

**WM361WW** 11/16 x 4-1/2



**WM452** 11/16 x 2-1/2  
**WM412** 11/16 x 3-1/2

# CASING

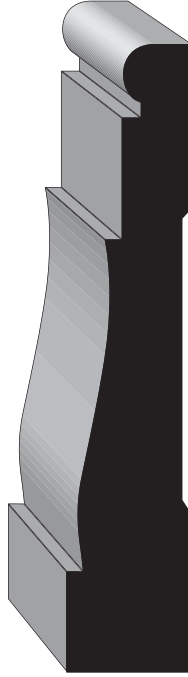

**WM445** 11/16 x 3-1/4  
**WM99** 11/16 x 3-1/2

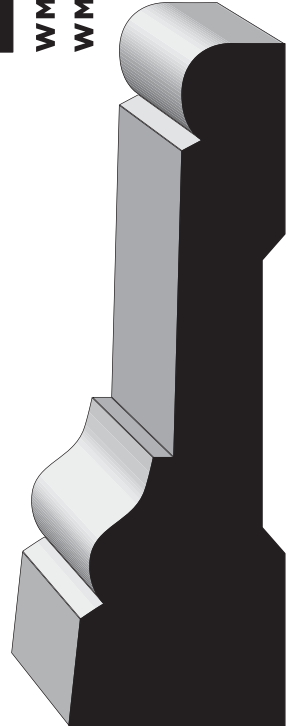

**WM97** 1-1/16 x 3-1/2  
**LWM97** 7/8 x 3-1/2

# CASING

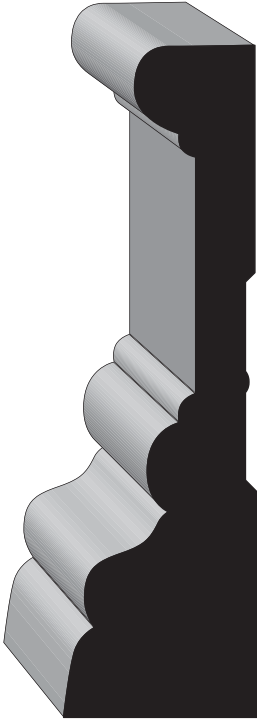

**WM96** 1-1/16 x 3-1/2  
**WMRB3** 1-1/16 x 3-1/2

# STOOL



**WM1020** 1-1/16 x 5-1/4

**WM1021** 11/16 x 5-1/4  
**WM1021W** 11/16 x 7-1/4  
**WM1022** 11/16 x 4-1/2  
**LWM1021** 11/16 x 3-1/2

# EXTENSION JAMB

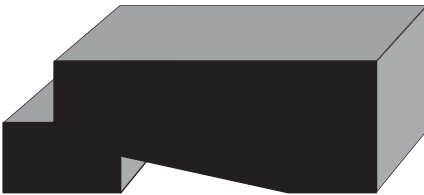

**WM1196** 11/16 x 1-15/16  
**WM1196W** 11/16 x 3-15/16

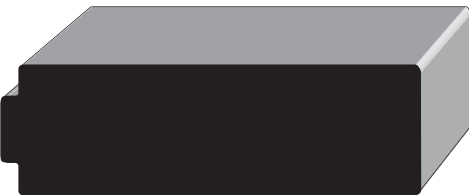

**WM1196T** 11/16 x 2-3/16

# STOOL



**WM1159** 1-1/16 x 5-1/4  
**WM1160** 1-1/16 x 4-1/4  
**WM1163** 1-1/16 x 3-1/4

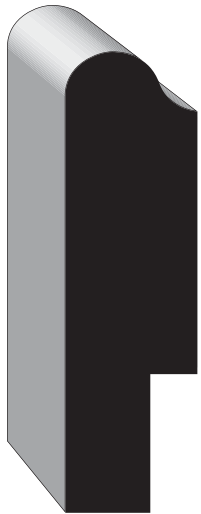

**WM1197** 11/16 x 2-3/8  
**WM1197W** 11/16 x 4-3/8



**WM1195** 11/16 x 2-1/2



**WM1199T** 11/16 x 2  
**WM1199WT** 11/16 x 4



**WM1199** 11/16 x 2  
**WM1199W** 11/16 x 4



**WM1197T** 11/16 x 2-3/8  
**WM1197WT** 11/16 x 4-3/8



**WM200** 11/16 x 2-1/2

## GLASS BEAD

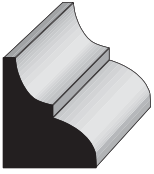

- WM146** 3/4 x 3/4
- WM147** 1/2 x 9/16
- WM148** 3/8 x 3/8

## SASH BEAD

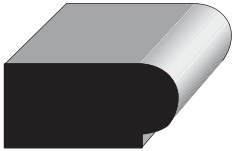

- WM953** 1/2 x 7/8
- WM953S** 7/16 x 1-1/8
- WM953WW** 7/16 x 1-3/8
- WM953XW** 7/16 x 1-5/8
- WM954** 1/2 x 1-1/8

## BACK BAND

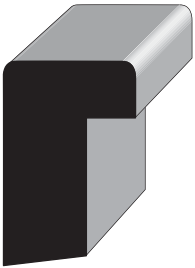

- WM280**  
11/16 x 1-1/16

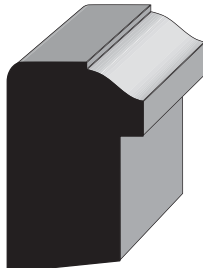

- WM281**  
11/16 x 1-1/16

## PLINTH

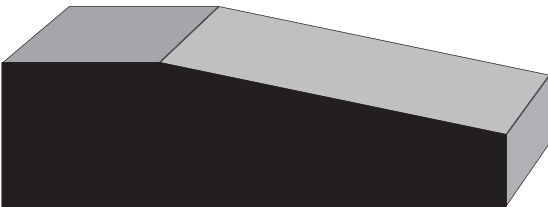

- WM9** 3/4 x 2-5/8
- WM10** 3/4 x 3-1/2
- WM11** 1-3/16 x 3-7/8

## SILL

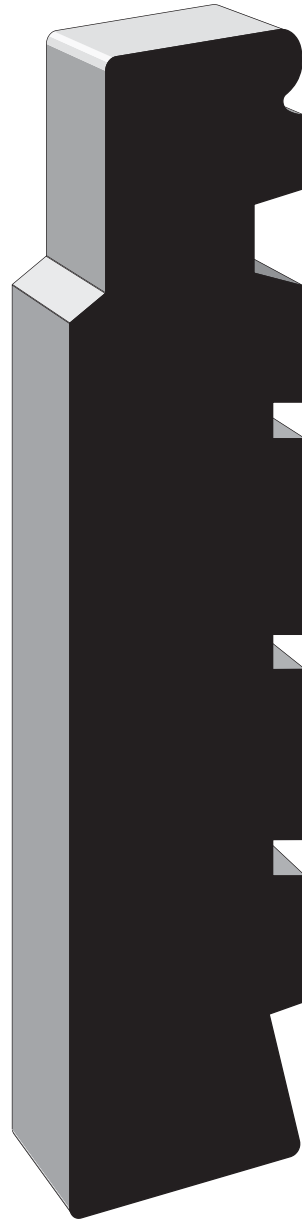

- WM1080** 1-1/4 x 6-1/4

## Profile Measurements

| Profile | Projection from Wall (A) | Rise on Wall (B) |
|---------|--------------------------|------------------|
| 44      | 2-11/16                  | 3-1/4            |
| 45      | 4-1/4                    | 4                |
| 47      | 2-5/8                    | 3-13/16          |
| 49      | 1-15/16                  | 3-1/32           |
| 53      | 1-17/32                  | 2-1/8            |
| 68      | 1                        | 1-7/32           |
| 70      | 1-5/8                    | 2-3/16           |
| 75      | 1-1/32                   | 1-3/16           |
| 80      | 2-7/8                    | 3-3/16           |
| 86      | 1-1/8                    | 1-1/8            |
| G86P    | 4-1/4                    | 4-1/4            |



## CROWN

CEILING

CEILING



**WM44**  
11/16 x 4-1/4

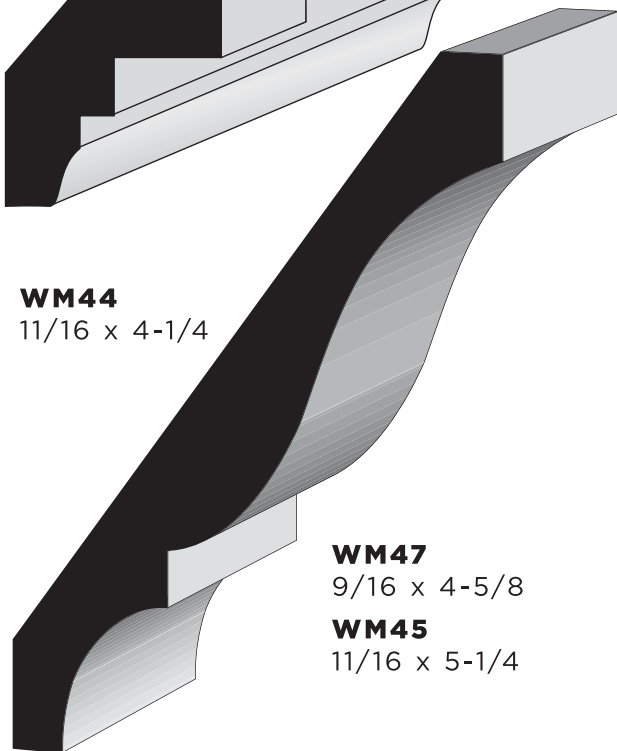

**WM47**  
9/16 x 4-5/8

**WM45**  
11/16 x 5-1/4



**WM49**  
9/16 x 3-5/8

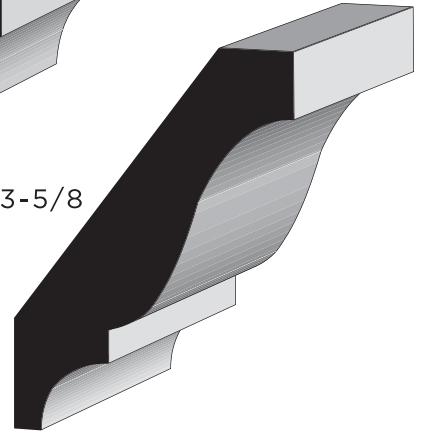

**WM53**  
9/16 x 2-5/8

**WM68**  
9/16 x 1-5/8

## BED



**WM70**  
9/16 x 2-3/4

**WM75**  
9/16 x 1-5/8

# COVE

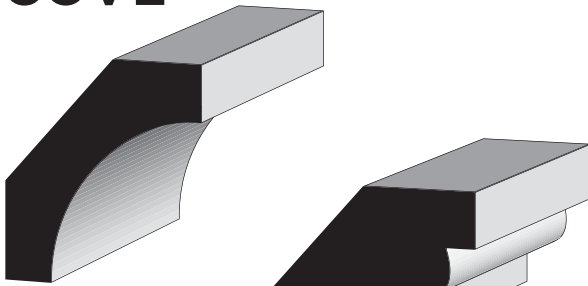

**WM86**  
9/16 x 1-5/8

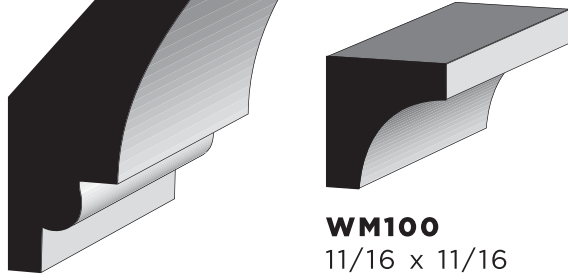

**WM80**  
11/16 x 4-1/4

**WM100**  
11/16 x 11/16

**WM101**  
1/2 x 1/2

# DENTIL

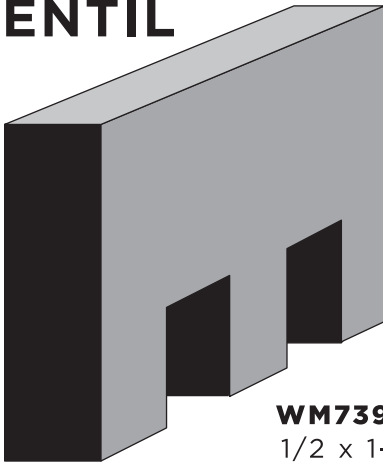

**WM739**  
1/2 x 1-3/4

# RAKE

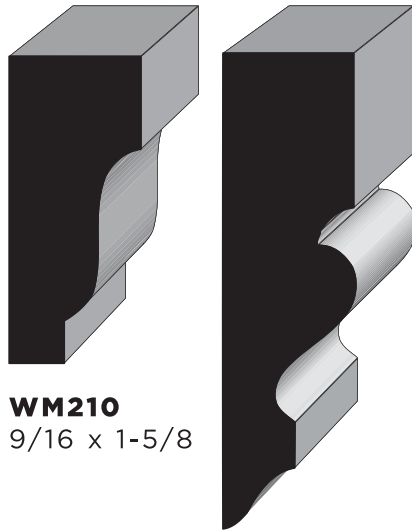

**WM210**  
9/16 x 1-5/8

**WM212**  
11/16 x 2-1/2

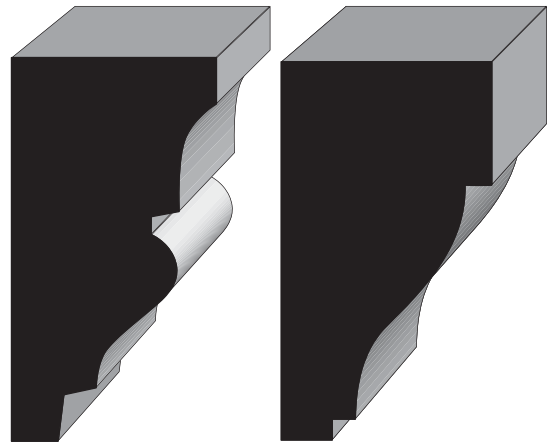

**WM286**  
1-1/16 x 2

**WM287**  
1-1/16 x 2

CEILING

CEILING



# CHAIR RAIL

WALL

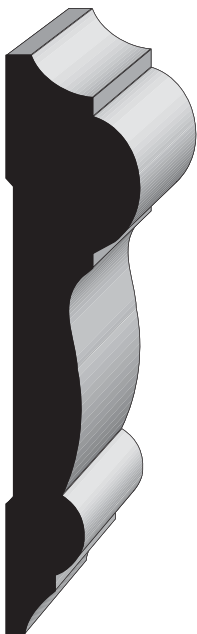

**WM297**  
11/16 x 3

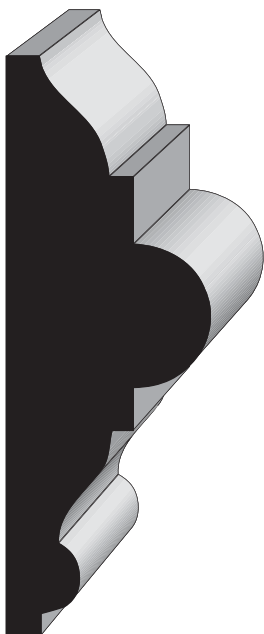

**WM300**  
1-1/16 x 3

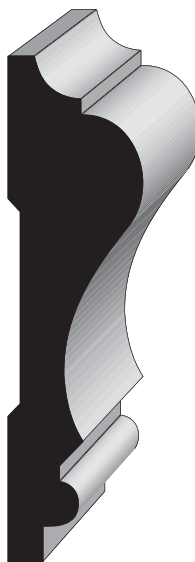

**WM390**  
11/16 x 2-5/8

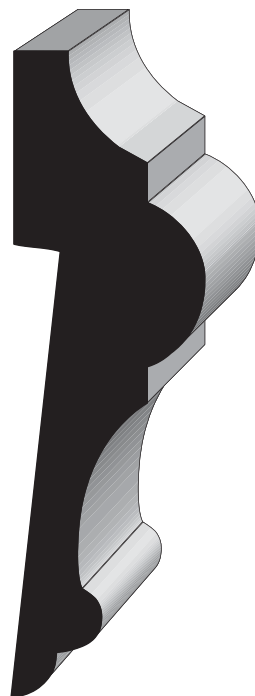

**WM301**  
1-1/16 x 3-3/8

WALL



**WM224**  
9/16 x 2-1/2

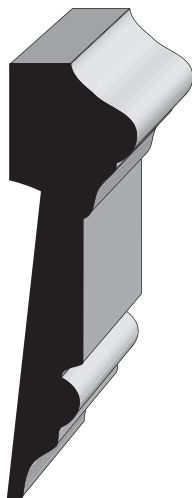

**WM77**  
11/16 x 2-1/4



**WM956W**  
7/16 x 3-1/4

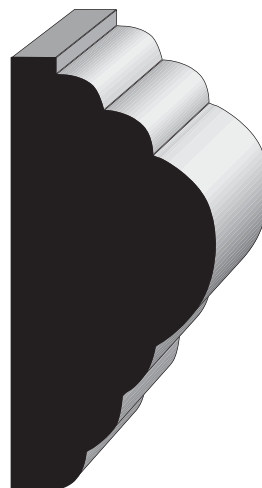

**WM303**  
1-1/16 x 2-1/4

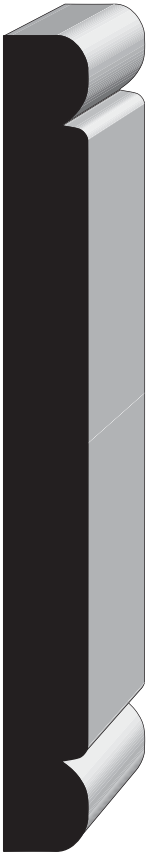

**WM956WW**  
7/16 x 4-1/4

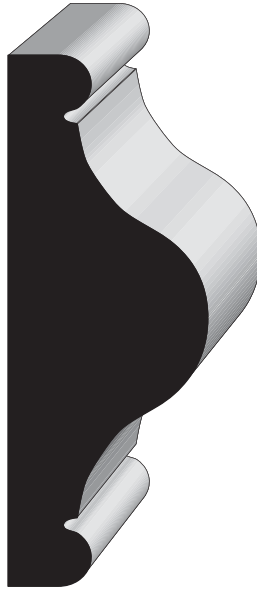

**WM302**  
1-1/16 x 2-3/4

## Item Index

## Wholesale Millwork

| item no | Description                           | Clear | FJ | Primed | MDF | Other | Section       |
|---------|---------------------------------------|-------|----|--------|-----|-------|---------------|
| 10      | WOOD PLINTH STOCK 3/4 X 3-1/2         | ■     |    |        |     |       | WINDOW/DOOR   |
| 100     | COVE 11/16 X 11/16                    | ■     |    | ■      |     | 0     | CEILING       |
| 101     | COVE 1/2 X 1/2                        | ■     |    |        |     |       | CEILING       |
| 1020    | STOOL 1-1/16 X 5-1/4                  |       |    | ■      |     |       | WINDOW/DOOR   |
| 1021    | STOOL 11/16 X 5-1/4                   | ■     | ■  | ■      | ■   |       | WINDOW/DOOR   |
| 1021W   | STOOL FJ 11/16 X 7-1/4                |       | ❖  | ■      | ■   |       | WINDOW/DOOR   |
| 1022    | STOOL FJ 11/16 X 4-1/2                |       |    | ■      | ■   |       | WINDOW/DOOR   |
| 103     | QUARTER RD MLDG 1-1/16 X 1-1/16       | ■     |    | ❖      |     |       | FLOOR         |
| 1030    | NOSING 1-1/16 X 1-1/4 OAK             |       |    |        |     | 0     | FLOOR         |
| 105     | QUARTER RD MLDG 3/4 X 3/4             | ■     |    |        |     |       | FLOOR         |
| 106     | QUARTER RD MLDG 11/16 X 11/16         | ■     |    | ■      |     | 0, V  | FLOOR         |
| 1060    | LANDING TREAD 1-1/16 X 3-1/4          | ■     |    |        |     | 0     | FLOOR         |
| 1060W   | OAK LNDG TREAD 1-1/16 X 5-1/4         | ■     |    |        |     | 0     | FLOOR         |
| 10750   | SCOTIA 1/2 X 3/4 OAK                  |       |    |        |     | 0     | FLOOR         |
| 108     | QUARTER RD MLDG 1/2 X 1/2             | ■     |    |        |     |       | FLOOR         |
| 1080    | PRIMED WINDO SILL 1-1/4 X 6 1/2       |       |    | ■      |     |       | WINDOW/DOOR   |
| 109     | QUARTER RD MLDG 3/8 X 3/8             | ■     |    |        |     |       | FLOOR         |
| 1090    | WAINSCOT 3/8 X 3                      |       |    |        |     | R     | PANEL         |
| 11      | WOOD PLINTH STOCK 1- 3/16 X 3-7/8     | ■     |    |        |     |       | WINDOW/DOOR   |
| 110     | QUARTER ROUND 1/4 X 1/4 SOLID         | ■     |    |        |     |       | FLOOR         |
| 1159    | STOOL 1-1/16 X 5-1/4                  | ■     |    |        |     |       | WINDOW/DOOR   |
| 1160    | STOOL 1-1/16 X 4-1/4                  | ■     |    |        |     |       | WINDOW/DOOR   |
| 1163    | STOOL 1-1/16 X 3-1/4 1-1/4 RAB        | ■     |    |        |     |       | WINDOW/DOOR   |
| 1164    | STL 1-1/4 RAB 11/16 X 2-3/4           | ■     |    |        |     |       |               |
| 1193    | STOOL 11/16 X 3-1/4                   | ■     |    |        |     |       |               |
| 1195    | STOOL 11/16 X 2-1/2                   | ■     |    | ■      |     |       | WINDOW/DOOR   |
| 1196    | ANDERSEN EXT JAMB 11/16 X 1-15/16     | ■     |    | ■      |     |       | WINDOW/DOOR   |
| 1196S   | EXT JAMB 11/16 X 2                    | ■     |    | ❖      |     |       | MISCELLANEOUS |
| 1196T   | AND TILT EXT JAMB 11/16 X 2-3/16      | ■     |    |        |     |       | WINDOW/DOOR   |
| 1196W   | WIDE AND EXT JAMB 11/16 X 3-15/16     | ■     |    | ■      |     |       | WINDOW/DOOR   |
| 1197A   | AND STOOL OG EDGE 11/16 X 2-3/8       | ■     |    | ■      |     |       | WINDOW/DOOR   |
| 1197T   | AND TILT STOOL OG 11/16 X 2-3/8       | ■     |    | ■      |     |       | WINDOW/DOOR   |
| 1197WA  | AND STL OG EDGE 11/16 X 4-3/8         | ■     |    | ■      |     |       | WINDOW/DOOR   |
| 1197WT  | WM1197W & TILT STOOL OG 11/16 X 4-3/8 | ■     |    | ■      |     |       | WINDOW/DOOR   |
| 1199    | AND STOOL BEV EDGE 11/16 X 2-3/8      | ■     |    | ■      |     |       | WINDOW/DOOR   |
| 1199T   | AND TILT STOOL BEV EDGE 11/16 X 2     | ■     |    | ■      |     |       | WINDOW/DOOR   |
| 1199W   | AND STL BEV EDGE 11/16 X 4-3/8        | ■     |    | ■      |     |       | WINDOW/DOOR   |
| 1199WT  | AND TILT STL BEV EDGE 11/16 X 4       | ■     |    | ■      |     |       | WINDOW/DOOR   |
| 120     | HALF ROUND 1/2 X 1                    | ■     |    |        |     |       | PANEL         |
| 1219    | CAP 11/16 X 1-5/8                     | ■     |    |        |     |       | MISCELLANEOUS |
| 122     | HALF ROUND 3/8 X 11/16                | ■     |    |        |     |       | PANEL         |
| 124     | HALF ROUND 1/4 X 1/2                  | ■     |    |        |     |       | PANEL         |
| 126     | SHOE 1/2 X 3/4                        | ■     |    |        |     | 0     | FLOOR         |
| 127     | SHOE 7/16 X 3/4 SANITARY              | ■     |    | ■      |     | 0,PF  | FLOOR         |
| 129     | SHOE 7/16 X 11/16 SANITARY            | ■     |    |        |     |       | FLOOR         |
| 1300-7  | T-ASTRAGAL 7" FOR 1-3/4 DOOR          |       |    |        |     | R     | DOOR          |
| 1305-7  | T-ASTRAGAL 7" FOR 1-3/8 DOOR          |       | ❖  |        |     | R     | DOOR          |
| 131     | SHOE 7/16 X 3/4 O.G.                  | ■     |    | ■      |     | 0     | FLOOR         |
| 133     | FLAT ASTRAGAL 11/16 X 1-3/4           | ■     |    |        |     |       | DOOR          |
| 134SN   | SILL NOSING PRIMED 1-3/4 X 1-1/8      |       |    | ❖      |     |       |               |
| 138     | SCREEN BEAD 5/16 X 5/8                | ■     |    |        |     |       | PANEL         |
| 142     | SCREEN BEAD 1/4 X 3/4                 | ■     |    |        |     | V     | PANEL         |
| 144     | SCREEN BEAD 1/4 X 3/4                 | ■     |    |        |     |       | PANEL         |
| 146     | GLASS BEAD 3/4 X 3/4                  | ■     |    |        |     |       | WINDOW/DOOR   |
| 147     | GLASS BEAD 1/2 X 9/16                 | ■     |    |        |     |       | WINDOW/DOOR   |
| 148     | GLASS BEAD 3/8 X 3/8                  | ■     |    |        |     |       | WINDOW/DOOR   |

| Item no | Description                        | Clear | FJ | Primed | MDF | Other | Section       |
|---------|------------------------------------|-------|----|--------|-----|-------|---------------|
| 163     | BASE CAP 11/16 X 1-3/8 OG & BEVEL  | ■     | ■  | ■      | ■   | 0     | FLOOR         |
| 163E    | EXT BASE COLONIAL 11/16 X 5-1/4    | ■     | ■  | ■      | ■   |       | FLOOR         |
| 163ES   | EXT BASE COLONIAL 9/16 X 5-1/4     | ■     | ■  | ■      | ◆   |       | FLOOR         |
| 163E7   | EXT BASE COLONIAL 11/16 X 7-1/4    | ■     | ■  | ■      | ■   |       | FLOOR         |
| 164     | BASE CAP 11/16 X 1-1/8 OG & BEVEL  | ■     |    |        |     | V     | FLOOR         |
| 165     | BASE CAP 11/16 X 1-3/8 OG          | ■     |    |        |     |       | FLOOR         |
| 167     | BASE CAP 11/16 X 1-1/8             | ■     | ■  | ■      |     |       | FLOOR         |
| 172     | CAP MOULDING 5/8 X 3/4             | ■     |    |        |     |       |               |
| 173     | PANEL MOULDING 1/4 X 1-3/8         | ■     |    |        |     |       | PANEL         |
| 174     | BRICK PRIMED 1-1/4 X 3-1/4         |       |    | ◆      |     | V     | DOOR          |
| 180     | BRICK 1-1/4 X 2                    | ■     |    | ■      |     | V     | DOOR          |
| 183     | PANEL MOULDING 9/16 X 1-1/8        | ■     |    |        |     |       | PANEL         |
| 184     | PANEL 1/2 X 1-1/2                  |       |    | ■      |     |       | PANEL         |
| 186     | PANEL MOULDING 3/8 X 1-1/8         | ■     |    |        |     |       | PANEL         |
| 188     | DRIP CAP 3/4 X 1-5/8 PVC MLDG      |       |    |        |     | V     | MISCELLANEOUS |
| 197P    | PRIMED DRIP CAP 11/16 X 1-5/8      |       |    | ■      |     |       |               |
| 200P    | PRIMED STOOL 11/16 X 2-1/2         |       |    | ■      |     |       | WINDOW/DOOR   |
| 201-8   | CORNER GUARD 1-1/4 X 1-1/4 OSC     | ■     |    |        |     |       | MISCELLANEOUS |
| 202-8   | CORNER GUARD 1-1/16 X 1-1/16 OSC   | ■     |    |        |     |       | MISCELLANEOUS |
| 204     | OUTSIDE CORNER SOLID PLAIN 1-1/4   | ■     |    |        |     |       | MISCELLANEOUS |
| 205     | CORNER GUARD 1-1/16 X 1-1/16 PLAIN | ■     |    |        |     |       | MISCELLANEOUS |
| 206     | CORNER GUARD 3/4 X 3/4 PLAIN       | ■     |    |        |     |       | MISCELLANEOUS |
| 207P    | RAKE MOULD PRIMED                  |       |    | ◆      |     |       |               |
| 210     | RAKE MOULDING 9/16 X 1-5/8         | ■     |    | ■      |     | V     | CEILING       |
| 212     | RAKE 11/16 X 2-1/2                 | ■     |    |        |     |       | CEILING       |
| 224     | CHAIRRAIL FLAT 9/16 X 2-1/2        | ■     |    |        |     |       | WALL          |
| 230     | HANDRAIL 1-9/16 X 1-11/16          |       |    |        |     | R     | RAIL          |
| 231     | HANDRAIL 1-9/16 X 1-11/16          |       |    |        |     | R     | RAIL          |
| 232     | FULL ROUND 1-9/16                  |       |    |        |     | R     | RAIL          |
| 233     | FULL ROUND 1-1/4                   |       |    |        |     | R     | RAIL          |
| 236     | S4S BALLUSTER 1-1/2 X 1-1/2        |       |    |        |     | R     | RAIL          |
| 237     | E4E BALLUSTER 1-1/4 X 1-1/4        |       |    | ■      |     | V,R   | RAIL          |
| 238     | S4S BALLUSTER 1-1/16 X 1-1/16      |       |    |        |     | R     | RAIL          |
| 240     | HANDRAIL 1-1/4 X 2-1/4             |       |    | ■      |     | R     | RAIL          |
| 246     | FLAT STOCK 11/16 X 2-5/8           | ■     |    | ■      |     |       | MISCELLANEOUS |
| 249     | FLAT STOCK 11/16 X 1-5/8           | ■     |    | ◆      |     |       | MISCELLANEOUS |
| 254     | PARTING BEAD 1/2 X 3/4             | ■     |    |        |     |       | MISCELLANEOUS |
| 265     | LATTICE 1/4 X 1-3/4                | ■     |    |        |     |       | PANEL         |
| 265W    | LATTICE 1/4 X 2                    | ■     |    |        |     |       | PANEL         |
| 265WW   | LATTICE 1/4 X 2-5/8                | ■     |    |        |     |       | PANEL         |
| 265XW   | LATTICE 1/4 X 5-1/4                | ■     |    |        |     |       | PANEL         |
| 266     | LATTICE 1/4 X 1-1/2                | ■     |    |        |     | V,T   | PANEL         |
| 266W    | LATTICE 1/4 X 1-5/8                | ■     |    |        |     |       | PANEL         |
| 267     | LATTICE 1/4 X 1-3/8                | ■     |    | ◆      |     |       | PANEL         |
| 268     | LATTICE 1/4 X 1-1/8                | ■     |    |        |     |       | PANEL         |
| 268S    | LATTICE 1/4 X 7/8                  | ■     |    |        |     |       | PANEL         |
| 276     | PICTURE MOULDING 11/16 X 1-3/4     | ■     |    |        |     |       | MISCELLANEOUS |
| 280     | BACK BAND 1-1/16 X 1-1/8           | ■     |    |        |     |       | WINDOW/DOOR   |
| 281     | BACK BAND 1-1/16 X 1-1/8           | ■     |    |        |     |       | WINDOW/DOOR   |
| 286     | RAKE MOULD 1-1/16 X 2              |       |    | ■      |     |       | CEILING       |
| 287     | RAKE MOULD PRIMED 1-1/16 X 2       |       |    | ■      |     | V     | CEILING       |
| 290     | CAP 11/16 X 1-3/8                  | ■     |    |        |     |       | MISCELLANEOUS |
| 295     | CAP 11/16 X 1-1/8                  | ■     |    |        |     |       | MISCELLANEOUS |
| 297     | CHAIRRAIL 11/16 X 3                | ■     |    | ■      | ■   |       | WALL          |
| 3       | PANEL MOULDING 9/16 X 1-1/2        | ■     |    |        |     |       | PANEL         |
| 300     | CHAIRRAIL 1-1/16 X 3               | ■     | ◆  | ■      | ■   |       | WALL          |
| 301     | CHAIRRAIL 1-1/16 X 3-3/8 RABB      | ■     |    |        |     |       | WALL          |

| Item no | Description                        | Clear | FJ | Primed | MDF | Other | Section       |
|---------|------------------------------------|-------|----|--------|-----|-------|---------------|
| 302     | CHAIRRAIL 1-1/16 X 2-3/4 HUMP      | ■     | ■  | ■      |     |       |               |
| 303     | CHAIRRAIL 1-1/16 X 2-1/4           | ■     |    |        |     |       | WALL          |
| 327     | CASING RANCH 11/16 X 2-1/4         | ■     |    | ■      |     |       | WINDOW/DOOR   |
| 356     | CASING COL. 11/16 X 2-1/4          | ■     |    | ■      |     |       | WINDOW/DOOR   |
| 361     | CASING FE EDGE 11/16 X 2-1/2       | ■     |    | ■      |     |       | WINDOW/DOOR   |
| 361W    | CASING FE EDGE 11/16 X 3-1/2       | ■     |    | ■      |     |       | WINDOW/DOOR   |
| 361WW   | CASING FE EDGE 11/16 X 4-1/2       | ■     |    | ■      |     |       | WINDOW/DOOR   |
| 366     | CASING FE EDGE 11/16 X 2-1/4       | ■     |    | ■      | ◆   |       | WINDOW/DOOR   |
| 370     | BEADED CASING 11/16 X 2-3/4        | ■     |    | ■      |     |       | WINDOW/DOOR   |
| 371     | BEADED CASING 11/16 X 2-1/2        | ■     |    | ■      |     |       | WINDOW/DOOR   |
| 376     | BEADED CASING 11/16 X 2-1/4        | ■     | ■  | ■      | ■   | O,V   | WINDOW/DOOR   |
| 37      | FLUTED CSG 11/16X 3-1/4            | ■     | ◆  | ■      |     |       | WINDOW/DOOR   |
| 390     | CHAIRRAIL 11/16 X 2-5/8            | ■     | ■  | ■      |     |       | WALL          |
| 412     | SANITARY CSG 11/16 X 3-1/2 R2E     | ■     |    | ■      |     |       | WINDOW/DOOR   |
| 412*    | SANITARY CSG 11/16 X 3-1/2 R1E     | ■     |    | ■      |     |       | WINDOW/DOOR   |
| 425     | BASE CAP 11/16 X 1-3/8             | ■     |    |        |     |       |               |
| 426     | BASE CAP 11/16 X 1-1/8             | ■     |    |        |     |       |               |
| 432     | SANITARY R2E CASING 9/16 X 3-1/2   | ■     |    | ■      |     |       | WINDOW/DOOR   |
| 432*    | SANITARY R1E CASING 9/16 X 3-1/2   | ■     |    | ■      |     |       | WINDOW/DOOR   |
| 44      | DENTIL CROWN 11-1/16 X 4-1/4       | ■     |    | ■      |     |       | CEILING       |
| 445     | BEADED CASING 11/16 X 3-1/4        | ■     | ■  | ■      | ■   | V     | WINDOW/DOOR   |
| 452*    | SANITARY R1E CASING 11/16 X 2-1/2  | ■     |    | ■      |     |       | WINDOW/DOOR   |
| 45      | CROWN MLDG 11/16 X 5-1/4           | ■     | ■  | ■      | ■   | V     | CEILING       |
| 462P    | PANEL MLDG PRIMED 1/2 X 1          |       |    | ◆      |     |       | PANEL         |
| 472     | SANITARY R2E CASING 9/16 X 2-1/2   | ■     |    | ■      |     |       | WINDOW/DOOR   |
| 47      | CROWN MLDG 9/16 X 4-5/8            | ■     | ■  | ■      | ■   | V     | CEILING       |
| 49      | CROWN 9/16 X 3-5/8                 | ■     | ■  | ■      | ■   | V     | CEILING       |
| 53      | CROWN 9/16 X 2-5/8                 | ■     |    | ■      |     |       | CEILING       |
| 530     | LIP MLDG 11/16 X 1-3/8             | ■     |    | ◆      |     |       | FLOOR         |
| 531     | LIP MLDG 11/16 X 1-5/8 10-LIP      | ■     |    | ■      |     |       | FLOOR         |
| 532     | LIP MLDG 11/16 X 1-5/8 10-LIP      | ■     |    | ■      |     |       | FLOOR         |
| 618     | FE EDGE BASE 9/16 X 5-1/4          | ■     |    | ■      | ◆   |       | FLOOR         |
| 620     | FE EDGE BASE 9/16 X 4-1/4          | ■     | ■  | ■      | ■   |       | FLOOR         |
| 622     | FE EDGE BASE 9/16 X 3-1/2          | ■     |    | ■      |     |       | FLOOR         |
| 623     | FE EDGE BASE 9/16 X 3-1/4          | ■     | ■  | ■      | ■   | 0     | FLOOR         |
| 624     | FE EDGE BASE 9/16 X 3              | ■     |    | ■      | ◆   |       | FLOOR         |
| 663     | FE EDGE BASE 9/16 X 3-1/4          | ■     | ■  | ■      | ■   |       | FLOOR         |
| 68      | CROWN 9/16 X 1-5/8                 | ■     |    |        |     |       | CEILING       |
| 70      | BED 9/16 X 2-3/4                   | ■     |    | ◆      |     |       | CEILING       |
| 713     | RANCH-CLAM BASE 9/16 X 3-1/4       | ■     |    | ■      |     |       | FLOOR         |
| 714     | RANCH-CLAM BASE 9/16 X 3-          | ◆     |    | ◆      |     |       | FLOOR         |
| 735DP   | CROWN BASE PRIMED 11/16 X 1-5/8    | ◆     |    | ◆      |     |       | CEILING       |
| 739     | DENTIL 1/2 X 1-3/4                 | ■     |    |        |     |       | CEILING       |
| 75      | BED 9/16 X 1-5/8                   | ■     |    | ■      |     | V     | CEILING       |
| 750     | BEADED BASE 9/16 X 4-1/4           | ■     | ■  | ■      |     |       | FLOOR         |
| 750W    | BEADED BASE 9/16 X 5-1/4           | ■     |    | ■      |     |       | FLOOR         |
| 753     | BEADED BASE 9/16 X 3-1/4           | ■     | ■  | ■      |     |       | FLOOR         |
| 77      | CHAIR RAIL RABBETTED 11/16 X 2-1/4 | ■     |    |        |     |       | WALL          |
| 7P      | MANTEL PRIMED 1-1/4 X 5-1/4        |       |    | ■      |     |       | MISCELLANEOUS |
| 80      | COVE 11/16 X 4-1/4                 | ■     |    | ■      |     |       | CEILING       |
| 855     | STOPS 3/8 X 1-5/8 RANCH            | ■     |    |        |     |       | DOOR          |
| 856     | STOPS 3/8 X 1-3/8 RANCH            | ■     |    |        |     |       | DOOR          |
| 858     | STOPS 3/8 X 1-1/8 RANCH            | ■     |    |        |     |       | DOOR          |
| 86      | COVE 9/16 X 1-5/8                  | ■     |    |        |     |       | CEILING       |
| 8840    | HANDRAIL 1-1/2 X 3-1/2             |       |    | ■      |     | R     | RAIL          |
| 8840F   | TOP FILLER FOR PVC HANDRAIL        |       |    | ■      |     |       | RAIL          |
| 8841    | BOTTOM RAIL 1-1/2 X 3-1/2          |       |    | ■      |     | R     | RAIL          |

| Item no | Description                        | Clear | FJ | Primed | MDF | Other | Section       |
|---------|------------------------------------|-------|----|--------|-----|-------|---------------|
| 8842F   | WOOD BOTTOM FILLER                 |       |    | ■      |     |       | RAIL          |
| 885     | STOPS 3/8 X 1-5/8 SANITARY         | ■     |    |        |     |       | DOOR          |
| 886     | STOPS 3/8 X 1-3/8 SANITARY         | ■     |    |        |     |       | DOOR          |
| 886FJ-7 | FJ. 3/8 X 1-3/8 STOP - 7/0         |       | ■  |        |     |       |               |
| 888     | STOPS 3/8 X 1-1/8 SANITARY         | ■     |    |        |     |       | DOOR          |
| 9       | WOOD PLINTH STOCK 3/4 X 2-5/8      | ■     |    |        |     |       | WINDOW/DOOR   |
| 945     | STOPS 3/8 X 1-5/8 WORKED           | ■     |    |        |     |       | DOOR          |
| 946     | STOPS 3/8 X 1-3/8 WORKED           | ■     |    | ■      |     |       | DOOR          |
| 948     | STOPS 3/8 X 1-1/8 WORKED           | ■     |    |        |     |       | DOOR          |
| 950     | STOP SOLID 3/8 X 7/8               | ■     |    |        |     |       | DOOR          |
| 951     | STOPS 3/8 X 3/4 WORKED             | ■     |    |        |     |       | DOOR          |
| 952     | STOP SOLID 3/8 X 5/8               | ■     |    |        |     |       | DOOR          |
| 953     | GLASS BEAD 1/2 X 7/8               | ■     |    |        |     |       | WINDOW/DOOR   |
| 953S    | GLASS BEAD 7/16 X 1-1/8            | ■     |    |        |     |       | WINDOW/DOOR   |
| 953WP   | PRIMED SASH BEAD 5/8 X 7/8         |       |    | ◆      |     |       |               |
| 953WW   | GLASS BEAD 7/16 X 1-3/8            | ■     |    |        |     |       | WINDOW/DOOR   |
| 953XW   | GLASS BEAD 7/16 X 1-5/8            | ■     |    |        |     |       | WINDOW/DOOR   |
| 954     | GLASS BEAD 1/2 X 1-1/8             | ■     |    |        |     |       | WINDOW/DOOR   |
| 956     | MULLION 3/8 X 2 BEADED             | ■     | ◆  | ■      |     |       | PANEL         |
| 956W    | W MULLION 7/16 X 3-1/4 BEADED WIDE | ■     |    |        |     |       | WALL          |
| 956WW   | MULLION 7/16 X 4 1/4 BDED EXWIDE   | ■     | ◆  | ■      | ◆   |       | WALL          |
| 957     | CH/RAIL BACKER 1/2 X 4-1/2         |       |    | ◆      |     |       |               |
| 958     | MULLION 3/8 X 1-1/2 BEADED         | ■     | ◆  | ■      |     |       | PANEL         |
| 959     | MULLION 3/8 X 1-1/8 BEADED         | ■     |    |        |     |       | PANEL         |
| 962     | LATTICE 3/8 X 2 S4S                | ■     |    |        |     |       | PANEL         |
| 96      | WINDSOR CASING 1-1/16 X 3-1/2      |       |    | ■      |     |       | WINDOW/DOOR   |
| 97      | CASING ADAMS 1-1/16 X 3-1/2        | ■     | ■  | ■      | ■   | V     | WINDOW/DOOR   |
| 972     | MULLION 3/8 X 2 R2E                | ■     |    |        |     |       | PANEL         |
| 982     | MULLION 3/8 X 2 FE                 | ■     |    |        |     |       | PANEL         |
| 989     | MULLION 3/8 X 1-5/8                | ■     |    |        |     |       | PANEL         |
| 995     | CHAMPHER STRIP 3/4 X 3/4           | ■     |    |        |     |       | MISCELLANEOUS |
| 996     | CHAMPHER STRIP 1 X 1               | ■     |    |        |     |       | MISCELLANEOUS |
| 99      | FJ BEADED CASING 11/16 X 3-1/2     | ■     |    | ■      |     |       | WINDOW/DOOR   |
| L1021P  | L PRIMED STOOL 11/16 X 3-1/2       |       |    | ■      |     |       | WINDOW/DOOR   |
| L97     | FJ BABY ADAMS CASING 7/8 X 3-1/2   |       | ■  |        |     |       | WINDOW/DOOR   |
| RB3     | ULTRA LITE ADAM CSG 25MM X 3-1/2   |       |    |        | ■   |       | WINDOW/DOOR   |
| L163    | BASE CAP 11/16 X 1-1/2             |       | ◆  | ◆      |     |       |               |
| P110    | 1X10 BOARD                         |       |    | ■      |     |       |               |
| P112    | 1X12 BOARD                         |       |    | ■      |     | 0     |               |
| P14     | 1X4 BOARD                          |       |    | ■      |     | 0     |               |
| P16     | 1X6 BOARD                          |       |    | ■      |     | 0     |               |
| P18     | 1X8 BOARD                          |       |    | ■      |     | 0     |               |
| P5410   | 5/4 X 10 PRIMED BOARD              |       |    | ■      |     |       |               |
| P5412   | 5/4 X 12 PRIMED BOARD              |       |    | ■      |     |       |               |
| P544    | 5/4 X 4 PRIMED BOARD               |       |    | ■      |     |       |               |
| P546    | 5/4 X 6 PRIMED BOARD               |       |    | ■      |     |       |               |
| P548    | 5/4 X 8 PRIMED BOARD               |       |    | ■      |     |       |               |
| OSB1116 | 1X12 OAK BOARD 16' VENEER          |       |    |        |     | 0     |               |

## KEY

■ = STOCKED AT ALL LOCATIONS  
 ◆ = STOCKED AT SOME LOCATIONS

○ = OAK

R = FIR

V = PVC

T = TREATED

PF = PRE-FINISHED

# BASE



**WM163E**  
11/16 x 5-1/4

**WM163ES**  
9/16 x 5-1/4

**WM163E7**  
11/16 x 7-1/4



**WM620**  
9/16 x 4-1/4

**WM618**  
9/16 x 5-1/4

FLOOR

# QUARTER ROUND

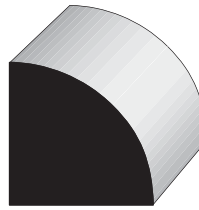

**WM103** 1-1/16 x 1-1/16

**WM105** 3/4 x 3/4

**WM106** 11/16 x 11/16

**WM108** 1/2 x 1/2

**WM109** 3/8 x 3/8

**WM110** 1/4 x 1/4

FLOOR



**WM750W**  
9/16 x 5-1/4

**WM750**  
9/16 x 4-1/4

**WM753**  
9/16 x 3-1/4



**WM663**  
9/16 x 3-1/4



**WM713**  
9/16 x 3-1/4

**WM714**  
9/16 x 3

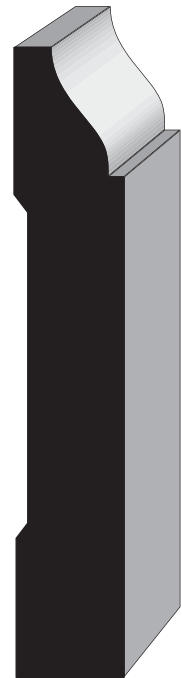

**WM623**  
9/16 x 3-1/4

**WM624**  
9/16 x 3

**WM622**  
9/16 x 3-1/2

FLOOR

# BASE CAP

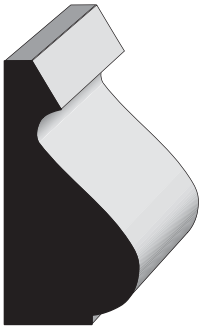

**WM163**  
11/16 x 1-3/8  
**WM164**  
11/16 x 1-1/8



**WM165**  
11/16 x 1-3/8  
**WM167**  
11/16 x 1-1/8

# STAIR



**WM1060** 1-1/16 x 3-1/4  
**WM1060W** 1-1/16 x 5-1/2

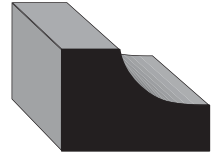

**WM1075** 1/2 x 3/4

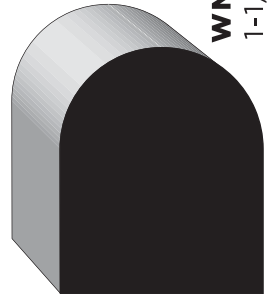

**WM1030**  
1-1/16 x 1-1/4

FLOOR

# SHOE

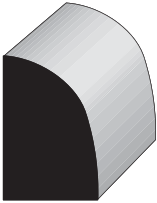

**WM125**  
5/8 x 7/8

**WM126**  
1/2 x 3/4

**WM127**  
7/16 x 3/4

**WM129**  
7/16 x 11/16

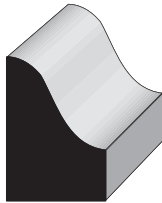

**WM131**  
7/16 x 3/4

FLOOR

# LIP

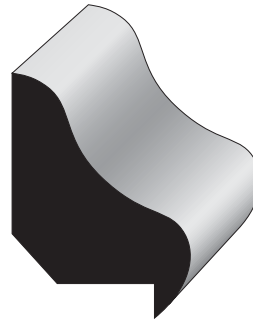

**WM532**  
11/16 x 1-5/8

**WM530**  
11/16 x 1-3/8

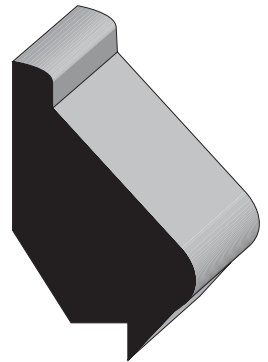

**WM531**  
11/16 x 1-5/8

# MULLION



- WM956** 3/8 x 2
- WM958** 3/8 x 1-1/2
- WM959** 3/8 x 1-1/8



- WM962** 3/8 x 2



- WM972** 3/8 x 2



- WM982** 3/8 x 2
- WM989** 3/8 x 1-5/8

# HALF ROUND

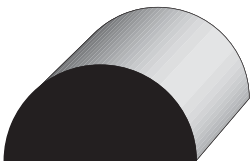

- WM120** 1/2 x 1
- WM122** 3/8 x 11/16
- WM124** 1/4 x 1/2

# PANEL



- WM173**  
1/4 x 1-3/8

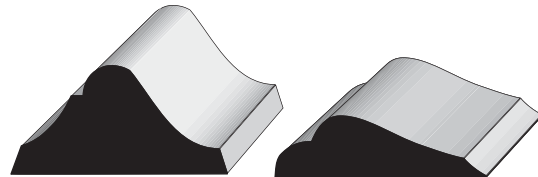

- WM183**  
9/16 x 1-1/8

- WM186**  
3/8 x 1-1/8

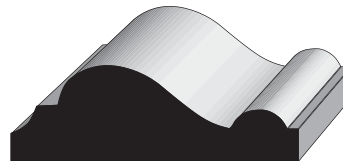

- WM184**  
1/2 x 1-1/2

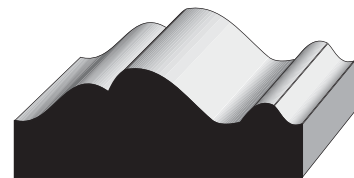

- WM3**  
9/16 x 1-1/2

# LATTICE



- WM265** 1/4 x 1-3/4
- WM265W** 1/4 x 2
- WM265WW** 1/4 x 2-5/8
- WM265XW** 1/4 x 5-1/4
- WM266** 1/4 x 1-1/2
- WM266W** 1/4 x 1-5/8
- WM267** 1/4 x 1-3/8
- WM268** 1/4 x 1-1/8
- WM268S** 1/4 x 7/8

PANEL

PANEL

## SCREEN BEAD

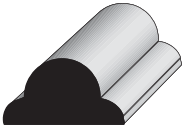

**WM138**  
5/16 x 5/8

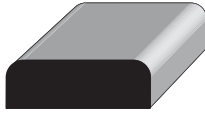

**WM142**  
1/4 x 3/4

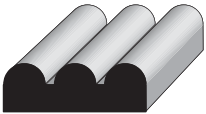

**WM144**  
1/4 x 3/4

## WAINSCOT



**WM1090** 3/8 x 3

## BRICK

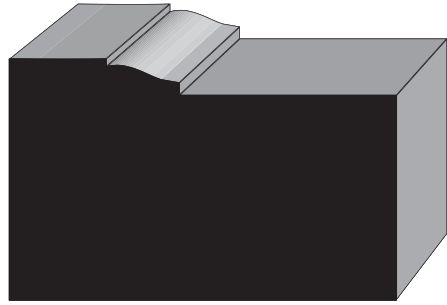

**WM180** 1-1/4 x 2

## ASTRAGAL

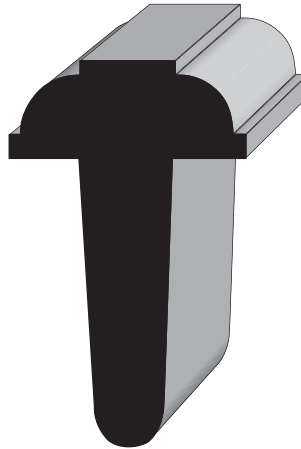

**WM1300** 1-1/4 x 2-1/4

**WM1305** 1-1/4 x 2

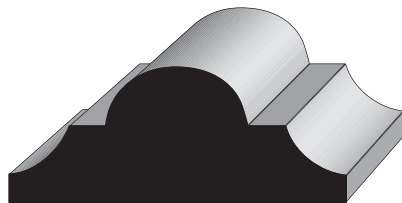

**WM133** 11/16 x 1-3/4

PANEL

DOOR



# STOP

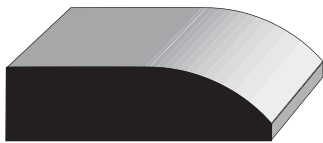

**WM855** 3/8 x 1-5/8

**WM856** 3/8 x 1-3/8

**WM858** 3/8 x 1-1/8



**WM885** 3/8 x 1-5/8

**WM886** 3/8 x 1-3/8

**WM888** 3/8 x 1-1/8



**WM945** 3/8 x 1-5/8

**WM946** 3/8 x 1-3/8

**WM948** 3/8 x 1-1/8

**WM951** 3/8 x 3/4

DOOR

# RAIL

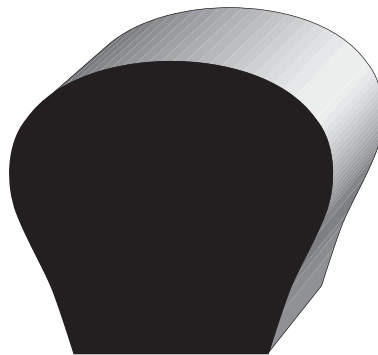

**WM230**

1-9/16 x 1-11/16

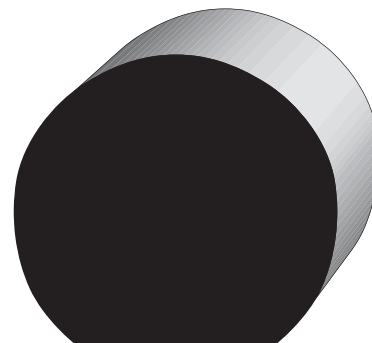

**WM231**

1-9/16 x 1-11/16



**WM240**

1-1/4 x 2-1/4

RAIL

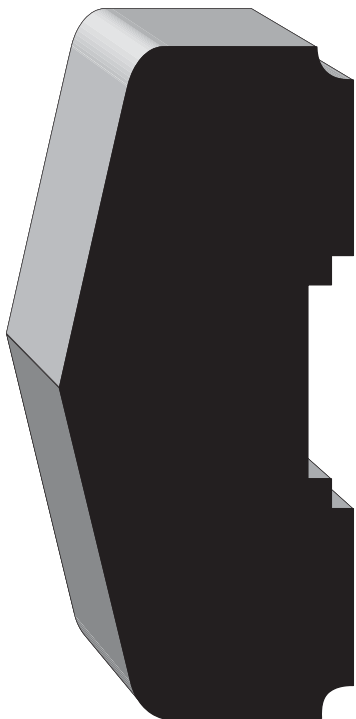

**WM8840** 1-1/2 x 3-1/2



**WM8841** 1-1/2 x 3-1/2

## FULL ROUND

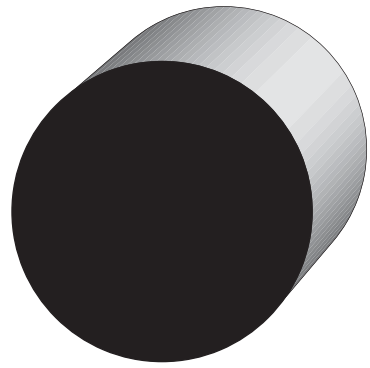

**WM232** 1-9/16

**WM233** 1-1/4

## BALUSTER

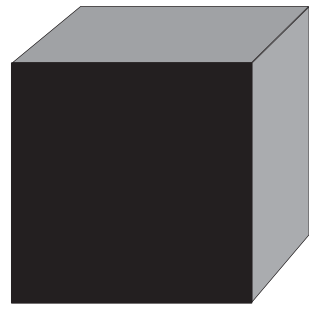

**WM236** 1-1/2 x 1-1/2

**WM237** 1-1/4 x 1-1/4

**WM238** 1-1/16 x 1-1/16

**WM239** 3/4 x 3/4

## CORNER GUARD

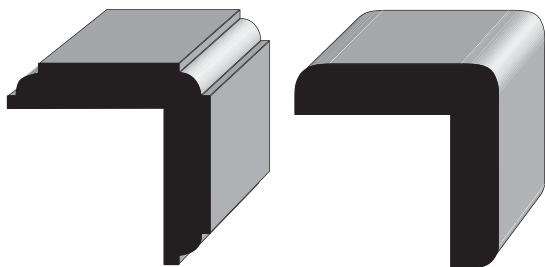

**WM202**

1-1/16 x 1-1/16

**WM201**

1-1/4 x 1-1/4

**WM204**

1-1/4 x 1-1/4

**WM205**

1-1/16 x 1-1/16

**WM206**

3/4 x 3/4

## PLY CAP



**WM1219**

11/16 x 1-5/8

**WM290**

11/16 x 1-3/8

## DRIP CAP

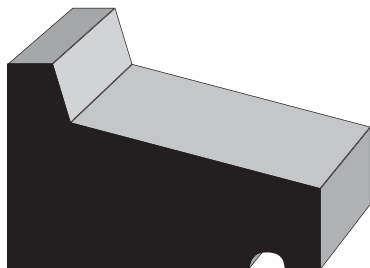

**WM188**

1-1/16 x 1-5/8



**WM295**

1/2 x 1-1/8

## CHAMFER

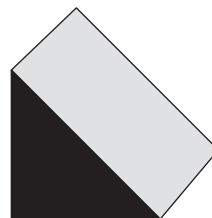

**WM995**

3/4 x 3/4

**WM996**

1 x 1

## PICTURE

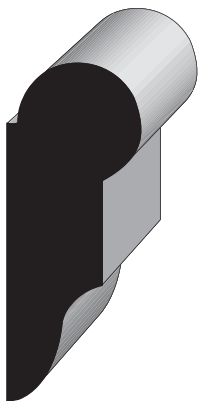

**WM276**

11/16 x 1-3/4

## PARTING BEAD

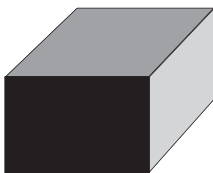

**WM254**

1/2 x 3/4

## S4S



**WM246** 11/16 x 2-5/8

**WM249** 11/16 x 1-5/8

**WM1196S** 11/16 x 2-1/16

# MANTEL

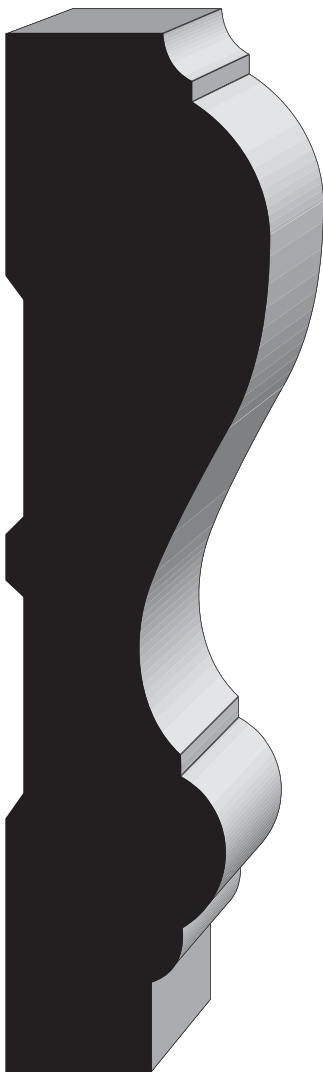

**WM7**  
1-3/8 x 5-3/8



## WHOLESALE MILLWORK

Wholesale Millwork is committed to providing professional lumber yards with quality products and excellent service. To meet this commitment, we stock a complete line of millwork products including Columns, Posts, Railing systems, stair parts, mouldings & boards. Our service is defined by excellent people, well managed inventories, and consistent deliveries on company trucks.

### **Delaware**

107 Park Avenue  
Seaford, DE 19973  
1-888-WM-4-TRIM  
1-888-964-8746

### **Maryland**

16618 Hunters Green Parkway  
Hagerstown, MD 21740  
1-866-WM-MLDGS  
1-866-966-5347

7364 Baltimore-Annapolis Blvd.  
Glen Burnie, MD 21061  
866 WM 4 MLDG  
866 964 6534

### **Pennsylvania**

184 Tuckerton Road, Unit 4  
Reading PA 19605  
1-877-WM-FOR-PA  
1-877-963-6772

### **Virginia**

11860 N Lake Ridge Parkway  
Ashland, VA 23005  
1-877-WM-FOR-VA  
1-877-963-6782

### **Email**

[info@wholesalemillwork.net](mailto:info@wholesalemillwork.net)

### **Website**

[www.wholesalemillwork.net](http://www.wholesalemillwork.net)



## Mouldings

We stock a wide range of high quality, expertly-crafted mouldings and we take custom orders as well. In addition to the many pine mouldings, we also have mouldings made of Ultra-Light MDF, Oak, Fir, and PVC.

## WM Resin Flex

WM Resin Flex is quality, hand-crafted, hard yet flexible resin that bends to fit curved architecture.



## TurnCraft Columns

Turncraft offers the architectural columns of choice which are designed from natural wood or virtually maintenance-free materials designed to stand beautifully for years. In addition, Turncraft can also meet all of your custom solutions options.



## Railing Dynamics Rail Systems Endurance Original Rail

ORIGINAL RAIL™ is a complete system of railing kits.



## Deck Rail

DECK RAIL™ includes an innovative wide cap design that beautifies and serves as an active surface on a deck.

## Endurance Crossover Product

CROSSOVER PRODUCT™ includes Post Wraps, Post Sleeves, Gates, Caps and Trim Rings.



## Novaline

The interchangeable parts of the Novaline Pearl White Collection, the Natural Collection, copper or stainless steel accents, and solar or low-voltage lighting combine to create an exciting new engineered wood railing system that can be adapted to an infinite number of different combinations.



## Strata Decking

Strata is a two-layered deck system.



## Crown Heritage Stair Parts

Crown Heritage defines visual perfection and style in a traditional stair system and leads the industry with its patented Crown System that provides perfect alignment of traditional stair systems.

